

LPG Premier
LPG Premier MidFlow
LPG Premier HiFlow

Installation Guide



Notice

Veeder-Root makes no warranty of any kind with regard to this publication, including, but not limited to, the implied warranties of merchantability and fitness for a particular purpose.

Veeder-Root shall not be liable for errors contained herein or for incidental or consequential damages in connection with the furnishing, performance, or use of this publication.

Veeder-Root reserves the right to change system options or features, or the information contained in this publication.

This publication contains proprietary information which is protected by copyright. All rights reserved. No part of this publication may be photocopied, reproduced, or translated to another language without the prior written consent of Veeder-Root.

Contact Red Jacket Technical Support for additional troubleshooting information at 800-323-1799.

DAMAGE GOODS/LOST EQUIPMENT

Thoroughly examine all components and units as soon as they are received. If any cartons are damaged or missing, write a complete and detailed description of the damage or shortage on the face of the freight bill. The carrier's agent must verify the inspection and sign the description. Refuse only the damaged product, not the entire shipment.

VR must be notified of any damages and/or shortages within 30 days of receipt of the shipment, as stated in our Terms and Conditions.

VEEDER-ROOT'S PREFERRED CARRIER

1. Fax Bill of Lading to V/R Customer Service at 800-234-5350.
2. Call V/R Customer Service at 800-873-3313 with the specific part numbers and quantities that were received damaged or lost.
3. VR will file the claim with the carrier and replace the damaged/missing product at no charge to the customer. Customer Service will work with production facility to have the replacement product shipped as soon as possible.

CUSTOMER'S PREFERRED CARRIER

1. Customer files claim with carrier.
2. Customer may submit a replacement purchase order. Customer Service will work with production facility to have the replacement product shipped as soon as possible.
3. If "lost" equipment is delivered at a later date and is not needed, VR will allow a Return to Stock without a restocking fee.
4. VR will NOT be responsible for any compensation when a customer chooses their own carrier.

RETURN SHIPPING

For the parts return procedure, please follow the instructions in the "General Returned Goods Policy" pages of the "Policies and Literature" section of the Veeder-Root North American Red Jacket Mechanical Products Price Book. Veeder-Root will not accept any return product without a Return Goods Authorization (RGA) number clearly printed on the outside of the package.

Introduction

ATEX Conditions for Safe Use: 1
 Safety Precautions 2
 Basic Principle of the Red Jacket Submersible LPG Pump 3
 Submerged LPG System Explanation 4
 The Electrical Conduit 5
 Direct Installation 5
 The Manifold 8
 By-Pass 13
 Equalization Line 13
 System Protection 14
 Potential Problems 14
 Low-pressure/Dry-Run Protection Unit (LPG Run Box) 15

Prior to Installing or Replacing LPG Pump or Motor

Electrical Service Information 17
 Marking 17
 Pump and Motor Weights 17

Installing A Red Jacket Submersible LPG Pump-Motor Unit

General 18
 System Description 18
 LPG Pump-Motor Unit 19
 Fitting the Pump-Motor Unit into the Manifold or Storage Tank 21
 Electrical Connection 21
 Determining Correct Motor Rotation 21
 Three-Phase Current Unbalance 21
 Typical System Schemes with Submersible LPG Pump-Motor Unit 22
 General 22
 Design and Test Pressures 22
 Material 23
 Flanges 23
 Name Plate 23
 System Components 23
 Gas Filling 28
 Gas Filling Requirements 28
 Gas filling procedure 28

Servicing The Red Jacket LPG Pump-Motor Unit

Degassing a Manifold and Replacing a Red Jacket LPG Pump-Motor Unit 29
 Prior to Starting 29
 Degassing Procedure 29
 Replace the pump and restart the installation 29
 Filling the manifold and pump-motor unit with liquid 30
 Maintenance of the Red Jacket Submersible LPG Pump-Motor Unit 31
 Yearly Inspections 31
 Troubleshooting Guide 32

Figures

Figure 1.	Direct Installation of Red Jacket LPG Pump-Motor Unit	6
Figure 2.	Vertical Manifold with Red Jacket LPG Pump-Motor Unit	9
Figure 3.	Horizontal Manifold With Red Jacket LPG Pump-Motor Unit	11
Figure 4.	Example installed position of LPG pumps within manifold	19
Figure 5.	Discharge Head	20
Figure 6.	Example percentage of unbalance calculation	22
Figure 7.	Typical Scheme For An Underground LPG Storage Tank With Vertical Submersible Pump-Motor Unit	25
Figure 8.	Typical Scheme For An Aboveground LPG Storage Tank With Horizontal Submersible Pump-Motor Unit	26
Figure 9.	Typical Scheme For A Direct Installation With Vertical Submersible Pump-Motor Unit	27
Figure 10.	Service Parts	31

Tables

Table 1.	LPG Pump-Motor Unit Models	4
Table 2.	Recommended Material List for Direct Installation of Red Jacket LPG Pump-Motor Unit (ref. Figure 1)	7
Table 3.	Recommended Material List for Vertical Manifold with Red Jacket LPG Pump-Motor Unit (ref. Figure 2)	10
Table 4.	Recommended Material List for Horizontal Manifold with Red Jacket LPG Pump-Motor Unit (ref. Figure 3)	12
Table 5.	Potential Performance Problems	14
Table 6.	Motor Package Contents	19
Table 7.	Required Data on Manifold Name Plate	23
Table 8.	Example System Components	23
Table 9.	Minimum Design Requirements Vertical Manifold	25
Table 10.	Minimum Design Requirements Horizontal Manifold	26
Table 11.	Service Parts List	31

Introduction

Improvements and market demand have resulted in the development of the latest LPG Premier and LPG Premier Mid-Flow and LPG Premier Hi-Flow pump-motor units for the Liquefied Petroleum Gas sector of the market place. These new ATEX certified pump-motor units contain the latest high temperature, non-conductive engineered materials. EC Type Examination Certificate marking is

CE 1180 Ex II 2G Ex b c d IIA T4 Gb

DEMKO 13 ATEX 9990794X

The Red Jacket submersible LPG pump and motor designs have more than twenty years of proven service throughout the world. All major oil and gas companies are using submersible technology. The pumps are used in filling stations for bottles, automobiles, trucks and buses. In the industrial sector installations include, but are not limited to, loading facilities, foam, aerosol and paper mills.

The Red Jacket submersible LPG pumps are electrical motor-driven centrifugal types designed for use in LPG filling station flow metering systems. The pumps are typically installed in a separate manifold direct into the storage vessels and are approved for use in Autogas motor fuels. Pumps can be installed in vertical and horizontal applications. The pump has a maximum rotational speed of 3000 RPM and is to be rigidly mounted to the electrical motor. The pumps provide positive pressure at all times to the flow meters.

The submersible LPG system installation consists of:

- A manifold including, overflow protector, shut off valve, equalization line, electrical junction box and a connection for a vapor return, pressure gauge and a separate connection for purge valve.
- A cable conduit entry of 1/2-14 inch NPTF threads mounted within the product line (column pipe).
- A motor with internal by-pass and pump section

The electric wires from the electrical junction box to the motor run through the conduit pipe. The conduit pipe is mounted inside the product line and is sealed against the pumped liquid. The electrical wires are mounted in a plug (pigtail) which provides a seal into the motor. The color-coded wires are provided with a LPG (propane and butane) resistant coating.

The pump-motor unit consists of two parts, the motor 50 Hz, 380-415 Vac (stator, rotor, electrical-connections and bearings) and the pump (multi-stage centrifugal). Motor and pump sections are each enclosed in stainless steel shells.









The United States Patent Office has granted patent number 6,129,529 to the pump-motor unit design.

ATEX Conditions for Safe Use:

- All submersible pump-motor units, manifolds and associated equipment shall be installed in accordance with the manufacturer's installation, operation and service manuals supplied and with local installation requirements.
- Drawing 410742-001 details dimensions of the flameproof joints, non-metallic materials and operating limits.
- This pump-motor unit is not intended to be repaired or adjusted. The pump and motor must be replaced as a complete set, not individually unless prior approval from Veeder Root is received.
- All installations shall provide reliable electrical connection between the submersible LPG pump, frame, piping, manifold or junction box and the tank structure for the electrical protection and equipotential bonding.
- The installer must supply a length of electrical conduit so that the motor conductors can be sealed and thereby separated from the pumped fluid.
- Fasteners securing the discharge head shall be replaced only by identical fasteners.
- Where a differential pressure switch or transducer is installed, each must be capable of ensuring that the nominated temperature classification is not exceeded.
- Compliance with the Essential Health and Safety Requirements has been assured by compliance with: EN 60079-0:2012, EN 60079-1:2007, EN 13463-1:2009, EN 13463-3:2005, EN 13463-5:2011, EN 13463-6:2005, DEMKO 13 ATEX 9990794X.

Safety Precautions

The following safety symbols are used throughout this manual to alert you to important safety hazards and precautions.

 <p>EXPLOSIVE Fuels and their vapors are extremely explosive if ignited.</p>	 <p>FLAMMABLE Fuels and their vapors are extremely flammable.</p>
 <p>WARNING Warning Alert - read message and follow instructions to avoid serious injury, death, or substantial property damage.</p>	 <p>TURN POWER OFF Live power to a device creates a potential shock hazard. Turn Off power to the device and associated accessories when servicing the unit.</p>
 <p>ELECTRICITY High voltage exists in, and is supplied to, the device. A potential shock hazard exists.</p>	 <p>FENCE OFF WORK AREA Fuels and their vapors are extremely explosive if ignited. Keep hazardous zone free of unauthorized personnel and vehicles. Put up fencing and/or barricades to safeguard work area.</p>
 <p>WEAR EYE PROTECTION Wear eye protection when working with pressurized fuel lines or epoxy sealant to avoid possible eye injury.</p>	 <p>GLOVES Wear gloves to protect hands from irritation or injury.</p>
 <p>READ ALL RELATED MANUALS Knowledge of all related procedures before you begin work is important. Read and understand all manuals thoroughly. If you do not understand a procedure, ask someone who does.</p>	

⚠ WARNING	
	<p>Portions of this product are to be installed and operated in the highly combustible environment of a LPG storage tank. It is essential that you carefully read and follow the warnings and instructions in this manual, failure to do so, can result in damage to property, environment, personal injury or death.</p>

- The equipotential bonding must be carried out by the installer in accordance with the nationally applicable installation regulations. For this purpose the piping components of the installed pump must be used.
- Protection against lightning reduces the risk of loss, damage or injury from direct strikes and against low energy surges.
- Protection provided by the various methods and approaches as prescribed by NFPA 780 and the IEC 62305 series of standards. Protection to the electronic equipment, communication and signal lines is ensured by providing surge protection to them.
- **FIRE HAZARD!** Do NOT use power tools during the installation or maintenance of equipment. Sparking could ignite fuel or vapors, resulting in fire. Use only spark-proof tools.

Note: This information is generated as a consequence of carrying out the ignition hazard assessment.

Basic Principle of the Red Jacket Submersible LPG Pump

Red Jacket submersible LPG pumps are multi-stage centrifugal pumps. The advantage of the multi-stage technology is maximum performance by a minimum of energy, respectively 2.25 kW (3 hp) for the Premier pump, 2.25 kW (3 hp) for the Mid-Flow and 3.75 kW (5 hp) for the Hi-Flow pump. During operation, the pressure increases with approximately 50 kPa (7.25 psi) per stage up to the maximum design pressure of the pump respectively 1000 kPa (145 psi) for Premier, 880 kPa (127 psi) for Mid-Flow and 1220 kPa (180 psi) for Hi-Flow. LPG is a mixture of gasses, primarily propane and butane which are vapors at atmospheric pressure. This means as long as the mixture is under sufficient pressure the mixture remains liquid.

Every stage consists of three parts; a. the diffuser, b. the diffuser plate and c. the impeller. The impellers are working on the floating principle. This means that during operation the impellers are floating in the liquid. Between the impeller and the diffuser and between the impeller and the diffuser plate there is a liquid film. This floating principle avoids any unnecessary resistance in the pump. As long as all the impellers are floating in the liquid, the pump runs on maximum capacity with a minimum of energy. All respectively, 17, 21 or 24 diffusers are interlocked and are enclosed in a stainless steel shell. There is not a requirement for initial bearing running-in period for the Red Jacket submersible LPG pumps.

For all types of Red Jacket submersible LPG pumps, the minimum differential pressure can never be allowed to go below 400 kPa (58 psi). This minimum required differential pressure of 400 kPa (58 psi) is to guarantee that during operation all respectively 17, 21 or 24 stages are submerged in the LPG liquid.

Another basic rule for a centrifugal pump is that there must be sufficient liquid available by the inlet of the pump. The pump can only build differential pressure when the first stage of the pump is completely submerged in the liquid. This NPSH (Net Positive Suction Head) is for all types Red Jacket submersible LPG pumps 127 mm (5.0 inches) above pump inlet opening.

The motors provided in these submersible pump-motor units are flameproof type 1180  II 2 G,

Ex d IIA Gb, with the certificates DEMKO 13 ATEX 9483031U and IECEx UL 13.0034U. They are designed to permit the LPG to flow through and around the motor and contain an internal bleed (by-pass).

The pumped liquid flows from the impellers between the motor shell and the stator, upward to the column pipe. A calculated part of the liquid passes through the motor flame barriers (breathers), motor bearings for cooling and lubrication. This amount of liquid passes through a self-adjusting bypass back into the pumped liquid. A calculated part of the pumped liquid passes through the internal by-pass to the manifold or storage tank to provide cooling for the pump/motor assembly.

Submerged LPG System Explanation

Table 1. LPG Pump-Motor Unit Models

<p style="text-align: center;">Premier</p> <p>Nomenclature: LPG300V17-21</p>	50 hertz, 380 – 415 Vac, 3 hp
	Setting thermal switch on the switch board: 6.1 amp
	70 liter/min by 680 kPa (18.5 gallon/min. by 98.6 psi) (max. efficiency)
	Max differential pressure 1000 kPa (145 psi)
	Capacity internal by-pass at max pressure: 20 liter/min. (5.3 gallon/min.)
	Minimum external flow - not required.
	Designed for 1-2 nozzles of 35 liter (9.2 gallon) simultaneously
<p style="text-align: center;">Premier MidFlow</p> <p>Nomenclature: LPG300V17-17</p>	50 hertz, 380 – 415 Vac, 3 hp
	Setting thermal switch on the switch board: 6.1 amp
	130 liter/min by 580 kPa (34.3 gallon/min. by 84 psi) (max. efficiency)
	Max differential pressure 880 kPa (127 psi)
	Capacity internal by-pass at max pressure: 20 liter/min. (5.3 gallon/min.)
	Minimum external flow - not required.
	Designed for 2-4 nozzles of 35 liter (9.2 gallon) simultaneously
<p style="text-align: center;">Premier HiFlow</p> <p>Nomenclature: LPG500V17-24</p>	50 hertz, 380 – 415 Vac, 5 hp
	Setting thermal switch on the switch board: 9.8 amp
	130 liter/min by 810 kPa (34.3 gallon/min. by 117 psi) (max. efficiency)
	Max differential pressure 1220 kPa (180 psi)
	Capacity internal by-pass at max pressure: 20 liter/min. (5.3 gallon/min.)
	Minimum external flow - not required.
	Designed for 4-5 nozzle's of 35 liter (9.2 gallon) simultaneously or 150 liter (39.6 gallon) for one nozzle

All calculations assume atmospheric pressure is 1013 mbar (14.7 psi) and outside temperature 15°C (59°F). Mixture is assumed to be 40% propane and 60% butane.

The pump-motor units are approved for use with butane and propane and any mix of butane and propane. It has been assumed that automotive LPG consists predominantly of propane, butane, with small proportions of propene, butenes and pentanes/pentenes.

Temperature range - 20°C to + 40°C (-4°F to +104°F)

System pressure - Max. 2500 kPa (362 psi)

Electric connection and motor protection - according to local regulation, or: NEN 1010 & NEN 3413 (Electrical components in Hazardous Areas), VDE 0100 & VDE 0165 (Electrical components in Hazardous Areas).

The pump-motor unit consists of two parts; the motor 50/60 Hz. 380 - 415 Vac (stator, rotor, electrical connections and bearings) and the pump (17, 21 or 24 impellers). Motor and pump are enclosed in stainless steel shells. The Red Jacket submersible Premier, Premier Mid-Flow or Premier Hi-Flow LPG pump is not repairable. The pump and motor of all three must be replaced as a complete set, not individually.

The stator is fitted with a containment shell of sheet metal and the windings are fully cast in epoxy. The section with the pigtail (discharge head) consists of a metal body (Ex 'd' flameproof enclosure) and electrical connections. The wires in the connectors are cast in epoxy. The rotor conductors are copper bars.

The Electrical Conduit

The installer must supply the electrical conduit so that the wires can be sealed from the pumped liquid. The pipe must be Schedule 80 and threaded 1/2-14 inch NPTF per ANSI B1.20.3 a length of 16.2 to 19.9 mm (0.64 to 0.78 inch). This will result in a thread engagement of 5 to 7 threads. Measurement of the thread profile is specified in ANSI B1.20.5. Female threads shall gauge at “flush” to “2 turns large” using an L1 plug-gauge. Apply Loctite 565, 570 or 577 thread sealant (Butane and Propane resistant) to both ends of the conduit pipe.

Direct Installation

Installing the submersible pump directly into the storage tank without a manifold is allowable only when permitted by local regulations.

In such installations, the clearance between the tank bottom and pump inlet must be a minimum of 125 mm (5 inches). A sump directly underneath the pump may be used if the size is at least DN200 (8 inches). Figure 1 illustrates recommendations for the Red Jacket LPG pump directly installed in a tank and Table 2 contains an itemized material list for the Figure 1 installation.

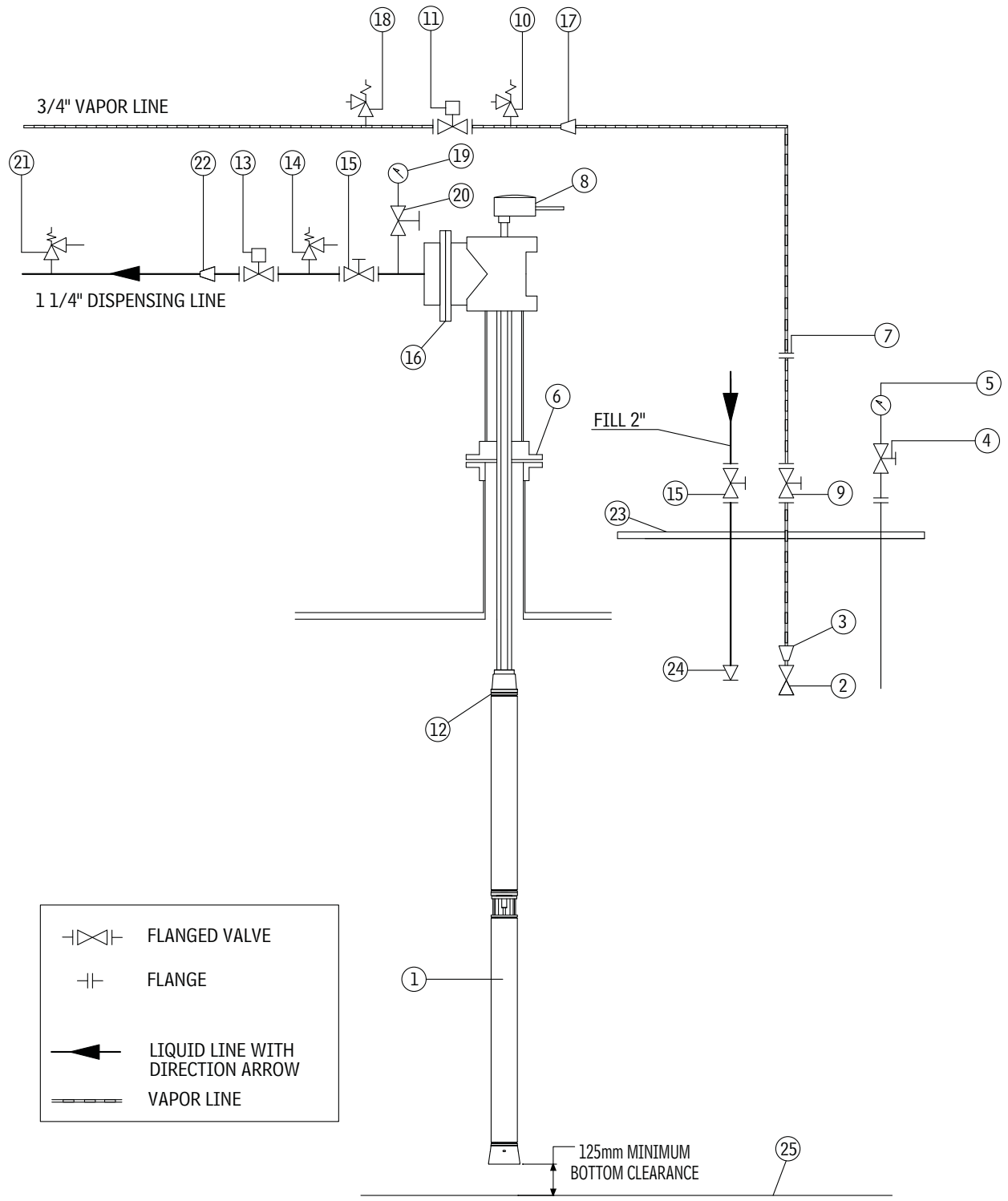

Figure 1. Direct Installation of Red Jacket LPG Pump-Motor Unit

Table 2. Recommended Material List for Direct Installation of Red Jacket LPG Pump-Motor Unit (ref. Figure 1)

Item	Description	Size (inches)	Recommended Manufacturer	Type/Remark	Other
1	Pump	4	Red Jacket	Premier/Premier MidFlow/ Premier HiFlow	
2	Excess flow valve	3/4	Rego	A3272 G (if applicable)	
3	Reducing socket	2 x 3/4		(if applicable)	
4	Ball valve	1/4	Argus	EK/71 (if applicable)	
5	Pressure gauge	1/4	Wika		
6	Flange	5		(if applicable)	
7	Flange	2			
8	Kit conduit box	1	Red Jacket	114-115-5	
9	Ball valve	2	Argus	EK/71	
10	Relief valve	1/4	Rego	3127 G	
11	Remote control valve	3/4	Argus	EK/71 (Pneu/Electrto)	
12	Internal bleed (bypass)		Red Jacket	Provided in pump motor	
13	Remote control valve	2	Argus	EK/71 (Pneu/Electrto)	
14	Relief valve	1/4	Rego	3127 G	
15	Ball valve	2	Argus	EK/71	
16	Flange	2			
17	Reducing socket	2 x 3/4			
18	Relief valve	1/4	Rego	3127 G	
19	Pressure gauge	1/4	Wika		
20	Ball valve	1/4	Argus	EK/71	
21	Relief valve	1/4	Rego	3127 G	
22	Reducing socket	2 x 1-1/4			
23	Manhole cover	20			
24	Check valve	2	Rego	A3186	
25	Tank bottom			125mm (5 inches) minimum to inlet	

The Manifold

According to the “Regulations”¹, a LPG submersible pump must be installed in a so-called pump well. This pump well (manifold) is designed so that the submersible pump can be installed and removed under any condition, i.e. when the storage vessel is either empty or (partly) filled.

A manifold is classified as an unfired pressure vessel, and is designed according to regulations for Pressure Vessels. The manifold must be suitable for the type of pump, to guarantee the above-described minimum requirements. Figure 2 illustrates a recommended vertical manifold for the Red Jacket LPG pump and Table 3 contains an itemized material list for the Figure 2 manifold.

1. “Regulations” in this manual refer to “Regulations for LPG Service Stations and Road Tank Trucks in the Netherlands”; Dutch Ministry of Housing, Physical Planning and Environment.

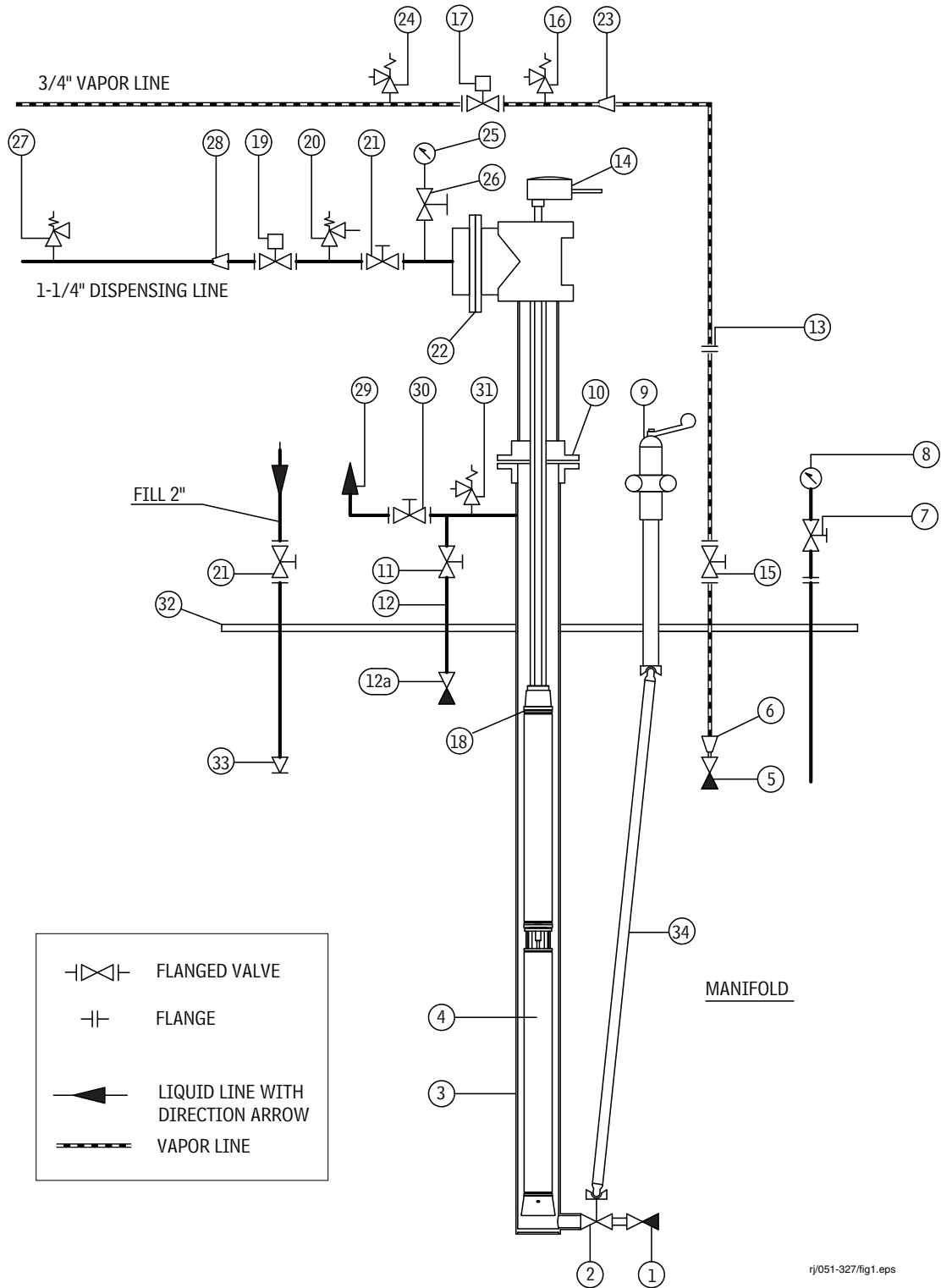

rj/051-327/fig1.eps

Table 3. Recommended Material List for Vertical Manifold with Red Jacket LPG Pump-Motor Unit (ref. Figure 2)

Item	Description	Size (inches)	Recommended Manufacturer	Type/Remark	Other
1	Excess flow valve	2	Rego	A3292 C (if applicable)	
2*	Ball valve	2	Worcester	A44	
3*	Manifold	5		acc. 8.5.2b Regulations	
4	Pump	4	Red Jacket	Premier/Premier MidFlow/ Premier HiFlow	
5	Excess flow valve	3/4	Rego	A3272 G (if applicable)	
6	Reducing socket	2 x 3/4		(if applicable)	
7	Ball valve	1/4	Argus	EK/71 (if applicable)	
8	Pressure gauge	1/4	Wika		
9*	Closing device	2		acc. 8.5.2h Regulations	
10*	Flange	5			
11*	Ball valve	1/2	Argus	EK/71	
12*	Equalization line			acc. 8.5.2c Regulations	
12a*	Excess flow valve	3/4	Rego	A3272 G (if applicable)	
13	Flange	2			
14*	Kit conduit box	1	Red Jacket	114-115-5	
15	Ball valve	2	Argus	EK/71	
16	Relief valve	1/4	Rego	3127 G	
17	Remote control valve	3/4	Argus	EK/71 (Pneu/Electrto)	
18	Internal bleed (bypass)		Red Jacket	Provided in pump motor	
19	Remote control valve	2	Argus	EK/71 (Pneu/Electrto)	
20	Relief valve	1/4	Rego	3127 G	
21	Ball valve	2	Argus	EK/71	
22*	Flange	2			
23	Reducing socket	2 x 3/4			
24	Relief valve	1/4	Rego	3127 G	
25	Pressure gauge	1/4	Wika		
26	Ball valve	1/4	Argus	EK/71	
27	Relief valve	1/4	Rego	3127 G	
28	Reducing socket	2 x 1-1/4			
29*	Vent of pump well	1/4		acc. 8.5.2b/c Regulations	
30*	Ball valve	1/4	Argus	EK/71	

Table 3. Recommended Material List for Vertical Manifold with Red Jacket LPG Pump-Motor Unit (ref. Figure 2)

Item	Description	Size (inches)	Recommended Manufacturer	Type/Remark	Other
31	Relief valve	1/4	Rego	3127 G	
32*	Manhole cover	NW 420 (ø525 mm)			
33	Check valve	2	Rego	A3186	
34*	Control rod				

The Red Jacket LPG pump can also be installed in a horizontal manifold. The pump unit must be supported by three load bearing supports inside the manifold. The manifold is generally mounted underneath the storage vessel and requires a vapor return/equalization line back to the vapor space of the storage vessel. Figure 3 illustrates a recommended horizontal manifold for the Red Jacket LPG pump and Table 4 contains an itemized list for the Figure 3 manifold.

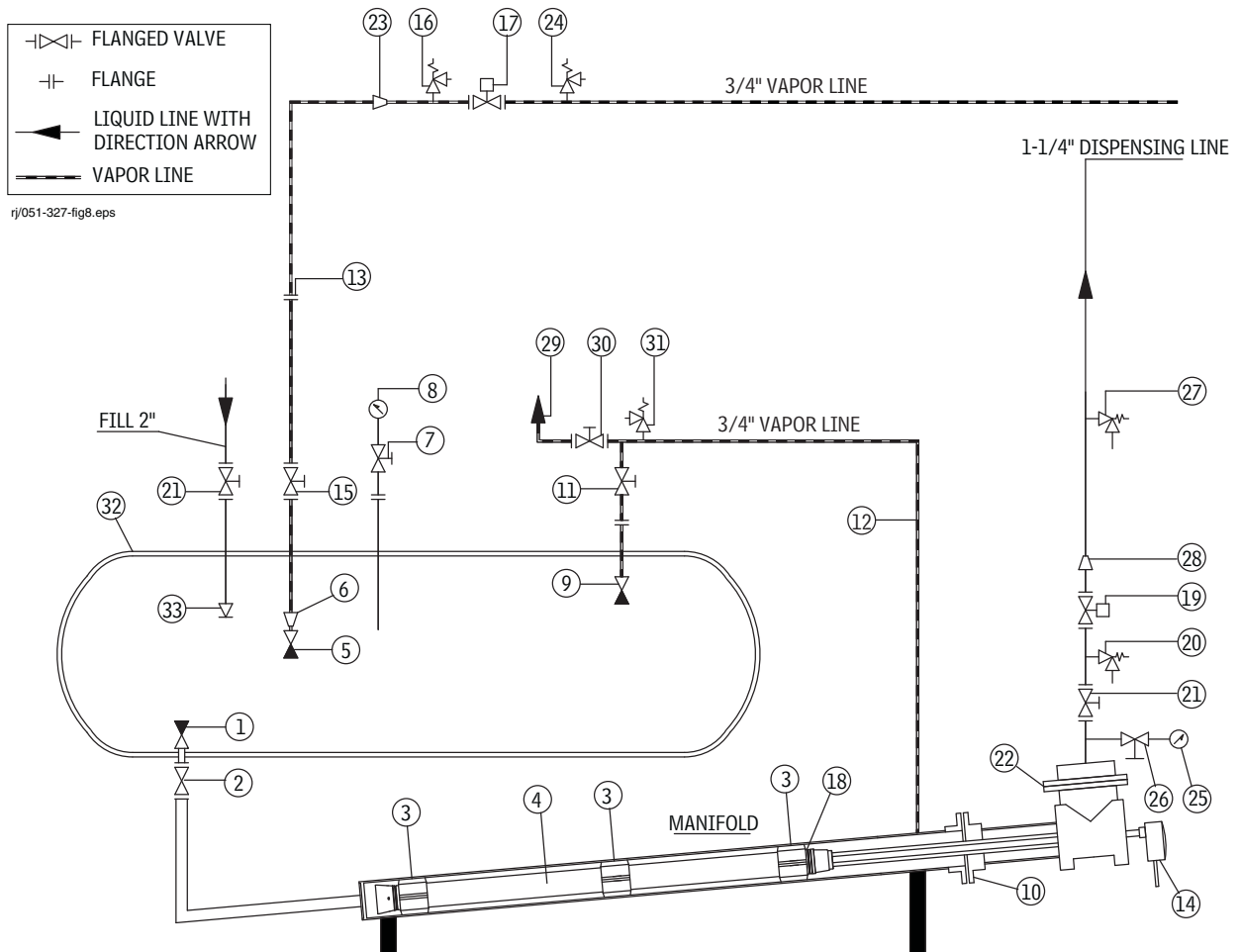

Figure 3. Horizontal Manifold With Red Jacket LPG Pump-Motor Unit

Table 4. Recommended Material List for Horizontal Manifold with Red Jacket LPG Pump-Motor Unit (ref. Figure 3)

Item	Description	Size (inches)	Recommended Manufacturer	Type/Remark	Other
1	Excess flow valve	2	Rego	A3292 C (if applicable)	
2*	Ball valve	2	Worcester	A44	
3	Isolator/Support	4	DSI	PA/PE4-38	3
4	Pump	4	Red Jacket	Premier/Premier MidFlow/ Premier HiFlow	
5	Excess flow valve	3/4	Rego	A3272 G (if applicable)	
6	Reducing socket	2 x 3/4		(if applicable)	
7	Ball valve	1/4	Argus	EK/71 (if applicable)	
8	Pressure gauge	1/4	Wika		
9	Excess flow valve	3/4	Rego	A3272 G	
10*	Flange	5			
11*	Ball valve	3/4	Argus	EK/71	
12*	Vapor return			acc. 8.5.2c Regulations	
13	Flange	2			
14*	Kit conduit box	1	Red Jacket	114-115-5	
15	Ball valve	2	Argus	EK/71	
16	Relief valve	1/4	Rego	3127 G	
17	Remote control valve	3/4	Argus	EK/71 (Pneu/Electrto)	
18	Internal bleed (bypass)		Red Jacket	Provided in pump motor	
19	Remote control valve	2	Argus	EK/71 (Pneu/Electrto)	
20	Relief valve	1/4	Rego	3127 G	
21	Ball valve	2	Argus	EK/71	
22*	Flange	3/4			
23	Reducing socket	2 x 3/4			
24	Relief valve	1/4	Rego	3127 G	
25	Pressure gauge	1/4	Wika		
26	Ball valve	1/4	Argus	EK/71	
27	Relief valve	1/4	Rego	3127 G	
28	Reducing socket	2 x 1-1/4			
29*	Vent of pump well/vapor return	1/4		acc. 8.5.2b/c Regulations	
30*	Ball valve	1/4	Argus	EK/71	

Table 4. Recommended Material List for Horizontal Manifold with Red Jacket LPG Pump-Motor Unit (ref. Figure 3)

Item	Description	Size (inches)	Recommended Manufacturer	Type/Remark	Other
31	Relief valve	1/4	Rego	3127 G	
32	Storage vessel				
33	Check valve	2	Rego	A3186	

By-Pass

All Red Jacket submersible LPG pumps are required to be coupled to a motor containing an internal bleed (by-pass).

The Premier pump developed maximum pressure is 1000 kPa (145 psi) differential pressure. The Premier Mid-Flow pump developed maximum pressure is 880 kPa (127 psi) differential pressure. The Premier Hi-Flow pump developed maximum pressure is 1220 kPa (180 psi) differential pressure. For pump technical reasons an externally mounted by-pass is not required.

According to the "Regulations" ¹, "An LPG pump shall be provided with an overflow/relief valve to protect the pump casing from overpressure when pumping against closed discharge. This bypass valve shall discharge into the LPG storage tank at a predetermined set pressure selected in relation to the pump operating pressure. This bypass valve shall be of sufficient capacity to handle the maximum flow at this pressure." The internal bleed in the Red Jacket LPG motor is designed according to this regulation.

When a local safety regulation requires an external by-pass this requirement must be applied. By the use of an external by-pass the setting must be above normal pump maximum pressure as stated above. By-pass must be of the soft-seat type without permanent bleed.

Equalization Line

The function of the equalization line is to equalize the pressure in the vapor space of the tank and the pressure of the manifold, to overcome running dry of the submersible pump by low liquid level and to equalize the pressure during refill of the installation.

The design of the equalization line must be so that the outside temperature has no influence on the function of the equalization line. An internal equalization line is recommended. Note if liquid level is below internal bleed in the motor, the amount of liquid of the internal bleed will increase the pressure in the manifold if the equalization line is too small.

The equalization line is one of the most important parts of the installation. As described above the equalization line needs to be as short as possible and relatively large in diameter. The lower the level of the liquid in the storage tank the more important is the function of the equalization line.

The functionality of the equalization line can be tested very easily when the liquid level is below the internal by-pass of the motor.

- Let the pump run against closed valve.
- Measure the differential pressure of the pump.
- If the differential pressure remains the same after 10 or 15 minutes of pump run the equalization line is working.
- If the pressure drops, the pump is cavitating, and the pump will become vapor-locked. In this case, the equalization line is not sufficient.

System Protection

Red Jacket recommends a complete system built around the pump to ensure safety, reliability, stability, and performance. If the entire system is calculated and built according to accepted specifications, the installation will operate for many years without requiring any form of maintenance.

There are two pump characteristics that can be checked if performance deteriorates:

1. Its output - flow rate versus pressure.
2. Its electrical connections and amperage consumed under load.

Potential Problems

Table 5. Potential Performance Problems

Problem	Solution
Dry run	A control box with low pressure detection can detect both of these performance problems.
Cavitation	
Equalization line in the manifold is too small	The Red Jacket LPG pump has an internal by-pass. A certain amount of LPG passes and cools the motor (self-maintaining principle) and exits the pump at the internal by-pass. The motor's heat is transferred to the liquid and is therefore warmer than the liquid in the tank. Also this liquid has a higher vapor pressure than does the liquid in the tank. The equalization line between the manifold and the tank is to balance both liquid levels. If this equalization line is too small or even closed, the manifold can be emptied through the manifold inlet and it can cause a dry run or even cavitation.
Dirt in the tank	Small parts of LPG dust or iron oxide, which can normally be found in LPG, will not hurt the system. During operation those particles can, however, block the breather plugs at the inlet of the pump-motor, but when the pump is switched off a small amount of liquid will be pressurized back in the tank. This amount of liquid will clean the breather plugs again. Of course, any form of dirt should be avoided and shortens the expected lifetime of the pump. It is recommended to install a strainer (100-micron) at the inlet of the storage tank to avoid dirt entering the tank during deliveries.

Red Jacket submersible LPG pumps are multi-stage centrifugal pumps. The advantage of the multi-stage technology is maximum performance by a minimum of energy, respectively 2.25 kW (3 hp) for the 21 stage Premier pump, 2.25 kW (3 hp) for the 17 stage Premier MidFlow pump and 3.75 kW (5 hp) for the 24 stage Premier HiFlow pump. During operation the pressure increases with approximately 50 kPa (7.25 psi) per stage up to the maximum design pressure of the pump respectively 1000 kPa (145 psi) for the Premier pump, 880 kPa (127 psi) for Premier MidFlow pump and 1220 kPa (180 psi) for Premier HiFlow pump.

For all types of Red Jacket submersible LPG pumps the minimum differential pressure can never be below 400 kPa (58 psi). This minimum required differential pressure is to guarantee that during operation all respectively 17, 21 or 24 stages are submerged in the LPG liquid. Another basic rule for a centrifugal pump is that there must be sufficient liquid available by the inlet of the pump. The pump can only build differential pressure when the first stage of the pump is completely submerged in the liquid. This so-called NPSH (Net Positive Suction Head) is 127 mm (5 inches) above pump inlet opening for all types Red Jacket submersible LPG pumps.

Cavitation is when the liquid flows with a velocity high enough to reduce the local pressure below vapor pressure forming small gas-filled bubbles. These gas-filled bubbles exhibit complex dynamics and erosive action on nearby surfaces.

When the temperature of LPG increases, it can vaporize. Vaporized liquefied petroleum gas expands at a rate of approximately 265:1. Due to the liquid vaporizing, sections of the LPG pump staging wear and will be damaged.

The motor of the pump needs to be cooled. Red Jacket does this by using the LPG. When operating, the LPG runs through and around the motor to cool it. In addition, LPG is used to lubricate the bearings. The first impeller of the pump needs to be submersed, so that the LPG can cool the motor. If the product level is too low, the motor cannot cool itself and the bearings will not be lubricated. Eventually the motor will fail.

When the pump is installed in a manifold another potential problem may occur. The equalization line is important to balance the liquid levels in the tank and the manifold. As stated above, the LPG cools the motor. Hence, some of the warmth of the motor is transferred to the LPG. Through the internal by-pass approximately 20 liters/min. (5.2 gallon/min.) will be pumped back in to the manifold. If, for any reason, the equalization line does not operate well, the liquid in the manifold can warm up. Consequently, the pressure in the manifold increases and, because of a higher-pressure level in the manifold compared to the tank pressure, all the liquid can be forced back in the tank, emptying the manifold. With the pump running, this is also a form of dry run.

Low-pressure/Dry-Run Protection Unit (LPG Run Box)

Red Jacket LPG pumps must be installed in accordance with the minimum requirements and it is to be recommended to include in the installation a so-called Low-pressure/Dry-Run protection unit (preferably based on pressure technology.) When installed according to the specifications, the pump will perform for many years.

When a pump fails it is mainly due to one of two events: cavitation or dry run. Veeder-Root does not warrant these two failures. The LPG Run Box is a safety device available for the Red Jacket submersible LPG pump that is designed to avoid cavitation and dry run of the unit.

The LPG Run Box is a differential pressure based system. When cavitation is about to occur, the pump cannot build up differential pressure. Similarly, with a dry run the pump cannot build up pressure as well. Basically, the LPG Run Box constantly receives pressure information of the total system and with this data it 'chooses' to stop or start the pump. A pressure transmitter is needed to send this information to the LPG Run Box. A pressure transmitter is thus a vital device of this system.

Since the LPG Run Box controls the pump, the LPG Run Box sends a signal to start the pump when a nozzle is picked up. Immediately, the pressure in the discharge line is compared to the vapor (or rest) pressure. If the differential pressure is greater than 100 kPa (14.7 psi) the system is OK. During operation, the LPG Run Box continues to check the differential pressure. The differential pressure needs to be above 400 kPa (58.9 psi). If the pressure falls below this given set point the LPG Run Box will turn the pump off. The pump is being protected from low pressure and low liquid level/dry run (no differential pressure). The system automatically restarts, but if the differential pressure continues to remain outside the working range, it stops and sounds an alarm.

Prior to Installing or Replacing LPG Pump or Motor

Read This Section before Proceeding

1. The Red Jacket submersible Liquefied Petroleum Gas (LPG) pump is designed to pump liquefied petroleum gas in the liquid state. This includes butane and propane and any mix of butane and propane. The vapor pressure of the liquid should not be more than 1380 kPa (200 psi) at 37.8°C (100°F). The density of the liquid should be less than 0.6 kg/l (37.4 lb./ft³). Pumping fluids other than LPG will overload the motor and damage the pump.
2. The pump should be installed according to local code regulations governing submersible LPG installations and also for ease in servicing. The pump is earthed (grounded) through the column pipe or the conduit pipe. The design of the mounting for the pumping unit shall be such as to prevent imposing any unacceptable loads on the on the storage vessel. Such loads might be caused by the weight of the various parts and/or by the forces due to operation of the pump including its starting and stopping but also by vibration. To minimize vibration, all pipe workings need to be securely mounted.
3. If a manifold or pump well is used, the maximum flow velocity at any point in the suction line from the tank must not exceed 1.0 m/sec. (3.3 ft./sec.). The equalization line must be of sufficient size to equalize the pressure of the manifold and supply vessel. The bottom of the pump inlet is to be aligned with the top of the manifold's inlet opening.
4. Installing the submersible pump directly into the storage tank without a manifold is allowable only when permitted by local regulations. In such installations, the clearance between the tank bottom and pump inlet must be a minimum of 125 mm (5 inches). A sump directly underneath the pump may be used if the size is at least DN200 (8 inches).
5. The pump is cooled and lubricated by the product being pumped. The required minimum differential pressure of 400 kPa (58 psi) is to guarantee that during operation all stages are submerged in the LPG liquid. The pump is designed to operate continuously or with an intermittent duty cycle, not to exceed 30 on/off cycles per hour.
6. Never wire pump to operate at less than 400 kPa (58 psi) differential pressure.
7. These submersible motors contain internal on-winding thermal protectors that will automatically trip at 110°C and reset at 52°C.
8. Red Jacket submersible LPG pumps are not designed to handle abrasive or foreign particles in the product being pumped other than small parts of LPG dust or iron oxide, which can normally be found in LPG. Do not use a pump inlet filter without written approval from Veeder-Root prior to its use. Installation of a strainer 0.1 mm (100 micron) in the inlet to the storage tank is recommended.
9. Red Jacket LPG pump-motor units are designed in accordance with European CENELEC and CEN Standards and the European Directive 94/9/EC (ATEX) "Equipment for Potentially Explosive Atmospheres" (CE₁₁₈₀ Ex II 2G Ex b c d IIA T4 Gb).
10. For maximum life, a submersible pump should not be run dry.
11. The ambient temperature is to be -20°C to +40°C.

Electrical Service Information

Model No.	HP	kW	Phase	Voltage Fluctuation Range		Hz	Service Factor amps	Locked Rotor amps	Winding Resistance (ohms)	I _A /I _N
				Min.	Max.					
P300V17-21	3.0	2.2	3	342	456	50	5.4	20	8.4 – 10.4	3.7
P300V17-17	3.0	2.2	3	342	456	50	5.4	20	8.4 – 10.4	3.7
P500V17-24	5.0	3.7	3	342	456	50	8.8	33	4.9 – 5.9	3.7

Marking

The manufacturer’s name and address, the motor model, serial number and date code, electrical rating and the EC Type Examination Certificate Number and warnings are permanently printed on the motor shell.

VEEDER-ROOT
 2709 ROUTE 764
 DUNCANSVILLE, PA 16635 USA

CE₁₁₈₀ Ex II 2G Ex b c d IIA T4 Gb
 DEMKO 13 ATEX 9990794X

RED JACKET SUBMERSIBLE LPG PUMP/MOTOR ASSEMBLY

MODEL XXXXXXX HP/KW X/XXX MAX AMPS XXX I_a/I_n XXX
 VOLTS XXXXXXX HZ XX PHASE X CONTINUOUS DUTY
 MAX AMBIENT 40°C DATE CODE XXXXX SERIAL NUMBER XXXXXX

DO NOT OPEN WHEN EXPLOSIVE ATMOSPHERE MAY BE PRESENT OR
 WHEN CIRCUIT IS ALIVE. SEE INSTALLATION MANUAL D051-327 FOR
 CONDUIT ENTRY REQUIRMENTS AND SAFE USE INSTRUCTIONS

The manufacturer’s name and address, the pump model, serial number and date code, horsepower (KW) rating, RPM, LPM, and the EC Type Examination Certificate Number and warnings are permanently printed on the pump shell.

VEEDER-ROOT
 2709 ROUTE 764
 DUNCANSVILLE, PA 16635 USA

1180 Ex II 1G IIA c
 DEMKO 13 ATEX 1303849U

RED JACKET SUBMERSIBLE LPG PUMP ASSEMBLY

MODEL XXX-XX HP/KW X/XXX HZ XX RPM XXXX LPM XXX
 MAX AMBIENT 40°C DATE CODE XXXXX SERIAL NUMBER XXXXXX

SEE INSTALLATION MANUAL 577014-063 FOR INSTALLATION
 REQUIREMENTS AND SCHEDULE OF LIMITATIONS

Pump and Motor Weights

Part Number	Model	Weight kg (lbs.)
410687-001	LPG-21	10 (21)
410687-002	LPG-24	10 (21)
410687-003	LPG-17	11 (24)
410686-001	P300V17	29 (64)
410686-002	P500V17	37 (82)

Note: the weights are approximate values and will vary due to manufacturing tolerances.

Installing A Red Jacket Submersible LPG Pump-Motor Unit

General



These instructions must be read fully before putting a submersible turbine pump for LPG into operation.

This LPG submersible pump is designed to pump a mixture of liquid petroleum gasses consisting of butane and propane, used as fuel to power motor vehicles.

These instructions only relate to the installation and operation of the submersible pump and not to the dispenser, which measures and registers the actual sales of the product.

The installation of the Red Jacket submersible LPG pumps should only be conducted in the presence of an authorized technician.

System Description

The Red Jacket submersible LPG pump is fitted into the special developed manifold, which has to be installed into one of the manholes of the storage tank (see below and Figure 4 for dimensions within manifold). At the bottom of the manifold a shut-off valve is installed, which can be operated from the outside above the storage tank, so the manifold can be closed. By closing this valve the pump can be separated from the stored fuel in the storage tank.

On the closing flange of the manifold a nitrogen connection is fitted. When nitrogen is admitted into the manifold, the LPG liquid is pressured back into the storage tank. When the shut-off valve is closed it is possible to safely remove or install the submersible LPG pump in a filled tank.

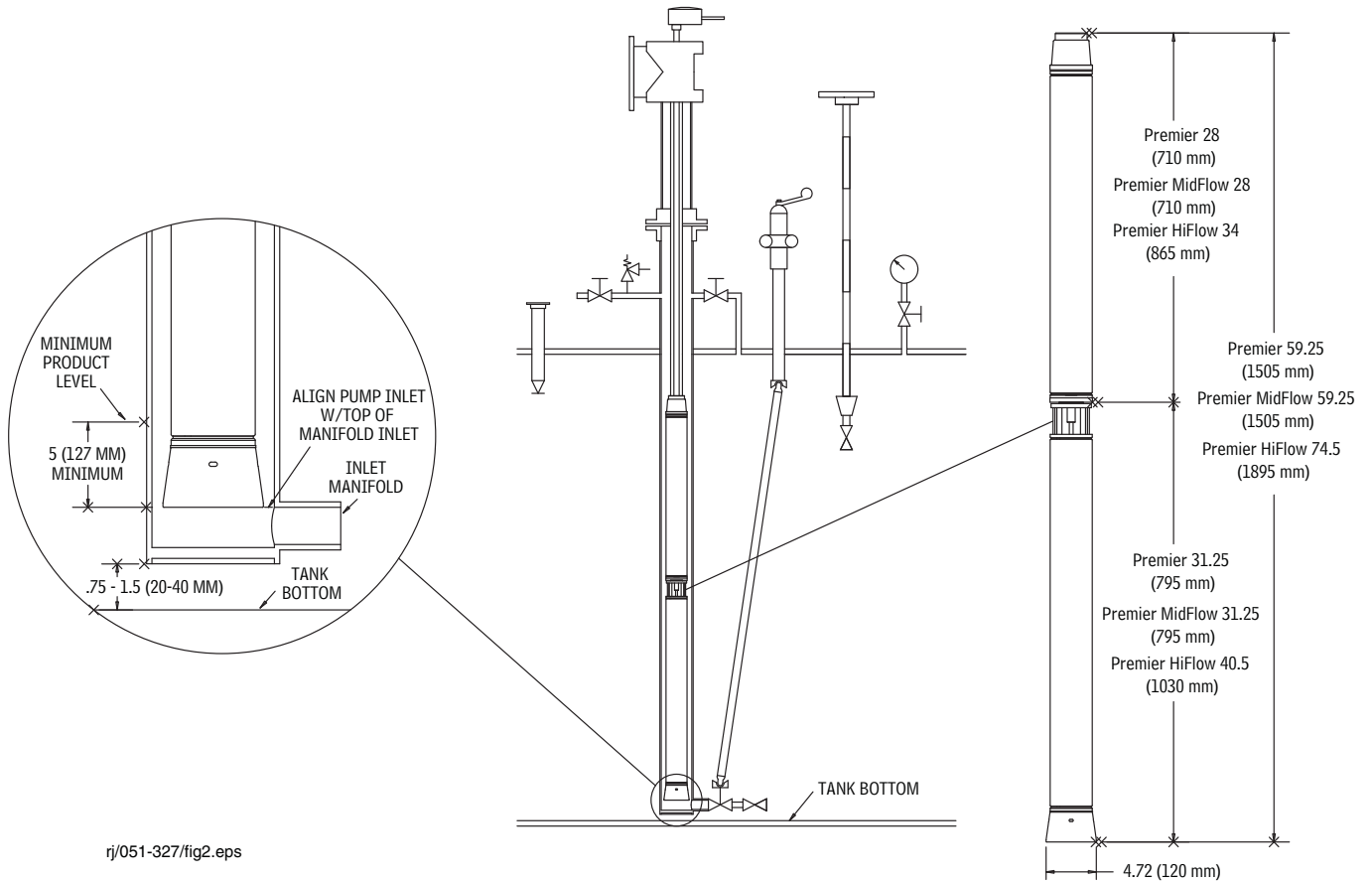

ry/051-327/fig2.eps

Figure 4. Example installed position of LPG pumps within manifold

LPG Pump-Motor Unit

Each package of new and replacement LPG motors contain the parts listed in Table 6:

Table 6. Motor Package Contents

Item	Qty
LPG motor	1
Discharge head with 2-inch NPT threads (1/2-14 NPTF)	1
Discharge head gasket	1
Pigtail connector, 14 AWG, 3 meter (10 feet)	1
Socket screws and lock washers, 5/16-18 inch	4 of each
O-ring, Viton, 53.6 x 2.6 mm (2.11 x 0.103 in.)	1
This Installation manual	1

If the discharge head is to be installed (see Figure 5), it must be connected to the piping before installing the pigtail connector and motor. The discharge head should be sealed with a blank fitting and the conduit pressure tested with nitrogen to 2000 kPa (290 psi). No leaks are allowed.

If using the existing discharge head, visually inspect the pigtail connector in the discharge head, replace if damaged. In addition examine the sealing surface of the discharge head - clean if necessary with fine emery paper.

The pigtail connector should be lubricated around its shell with petroleum-based jelly, PTFE lubricant or a suitable alternative. Assemble the pigtail connector in the discharge head making sure the key in the shell aligns with the notch in the discharge head.

The supplied o-ring (53.6 x 2.6 mm [2.11 x 0.103 in.]) is to be installed in the groove at the top of the pump if needed. It should be lubricated with petroleum-based jelly, PTFE lubricant or a suitable alternative.

Verify that the end of the motor coupling extends a minimum of 43 mm (1.7 in.) from the mounting face.

The pump should be carefully positioned to the bottom of the motor by first aligning the pump shaft with the motor coupling. Secure the pump to the motor by using the cap screws and lock washers supplied with the pump. Using a torque wrench, the screws should be tightened to 28 - 31 ft-lb. (37.8 - 41.9 N•m) each.

The supplied o-ring (25.4 x 1.8 mm [1.0 x 0.070 in.]) installed in the groove at the top of the motor should be lubricated with petroleum-based jelly, PTFE lubricant or a suitable alternative.

After fitting the gasket to the top of the motor, the motor should be carefully positioned snug to the discharge head and secured using the supplied socket screws and lock washers. Using a torque wrench, the screws should be tightened to 10 - 15 ft-lb. (13.5 - 20.3 N•m) each using a cross pattern.

Test the insulation resistance of each motor lead to the metal junction box. Repair if any reading is less than 2 Meg ohms.

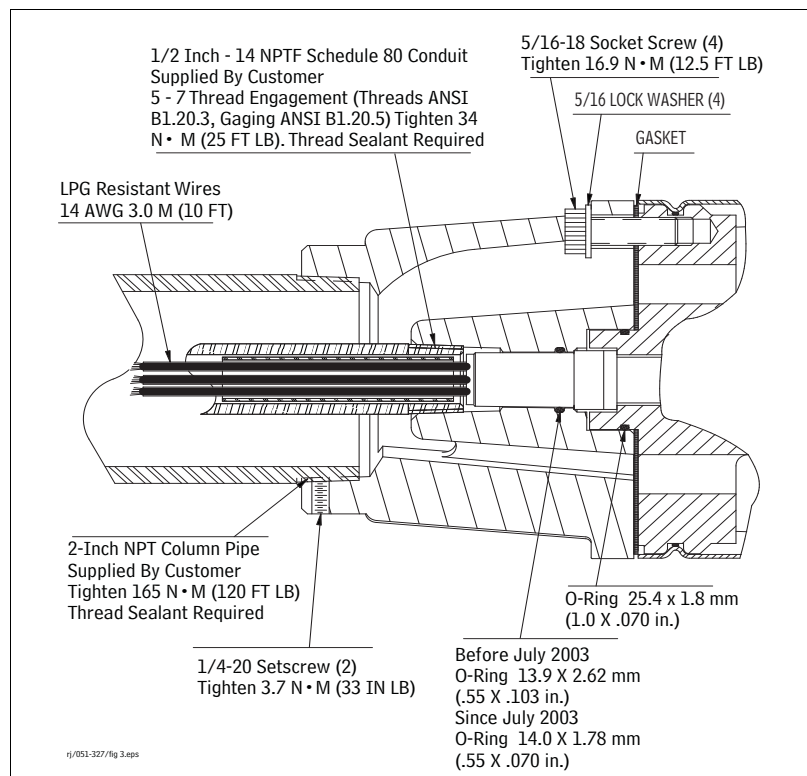

Figure 5. Discharge Head

Fitting the Pump-Motor Unit into the Manifold or Storage Tank

The pump-motor unit should be carefully lifted by suitable means that will provide control and stability while lowering the unit through the opening.

Electrical Connection



The electrical path must include a vapor sealing device, such as a compound sealing Y-fitting or EEx cable entry between the pump and junction box as per local code regulations.



1. **Disconnect, lock out, and tag the power before starting to service the pump.**
2. Connect the three-phase power supply from the master panel to terminals L1, L2, and L3 in the magnetic starter.
3. Before running the pump, the tank and pump well must contain LPG and be purged of air following recommended procedures contained in this manual and per local regulations.

Determining Correct Motor Rotation

Where it is not convenient to predetermine the power supply phase sequence, proper rotation can be determined by pump performance. Pump head pressure and capacity will be considerably less than rated when the pump is rotating backwards.

Using coded wires, connect a wire from terminal T1 in the magnetic starter to a pump wire in the junction box of the appropriate submerged pump. Connect another wire from starter terminal T2 to another pump wire and a third wire from T3 to the last pump wire.

With ample LPG in the tank and pump well, start the pump and take a pressure gauge reading of the pump pressure with the ball valve closed.

Next, reverse power leads at magnetic starter. Repeat pressure test, as described above. If results are higher than the first test, the rotation during the second test is correct. If the second test gives lower results than the first, reconnect the power leads as they were initially (as under test 1) for correct rotation.

Where the power supply has been properly marked L1, L2, and L3 in accordance with accepted phase rotation standards, it is possible to predetermine the proper rotation of these units. The pump power leads are color coded orange, black, and red, and if connected through the magnetic starter to L1, L2, and L3 respectively, the motor will rotate in the correct direction. It is recommended, however, that the performance tests always be made whether or not the power supply has been properly 'phased out'.

Three-Phase Current Unbalance

Three-phase current unbalance is a factor that can result in premature motor failure. It causes reduced starting torque, excessive and uneven heating and excessive motor vibration. Therefore, it is important that the electrical load to the submersible motor be balanced. After the correct motor rotation is established, the amount of current unbalance among the three legs of the power supply should be calculated.

To prevent changing motor rotation when taking these readings, the wires to the pump should be moved across the starter terminals by always moving them in the same direction.

Percentage unbalanced = maximum current difference from average current divided by average current times 100.

As seen in the example in Figure 6, the third connection has the lowest percentage of unbalance and should be used to obtain maximum motor efficiency and reliability.

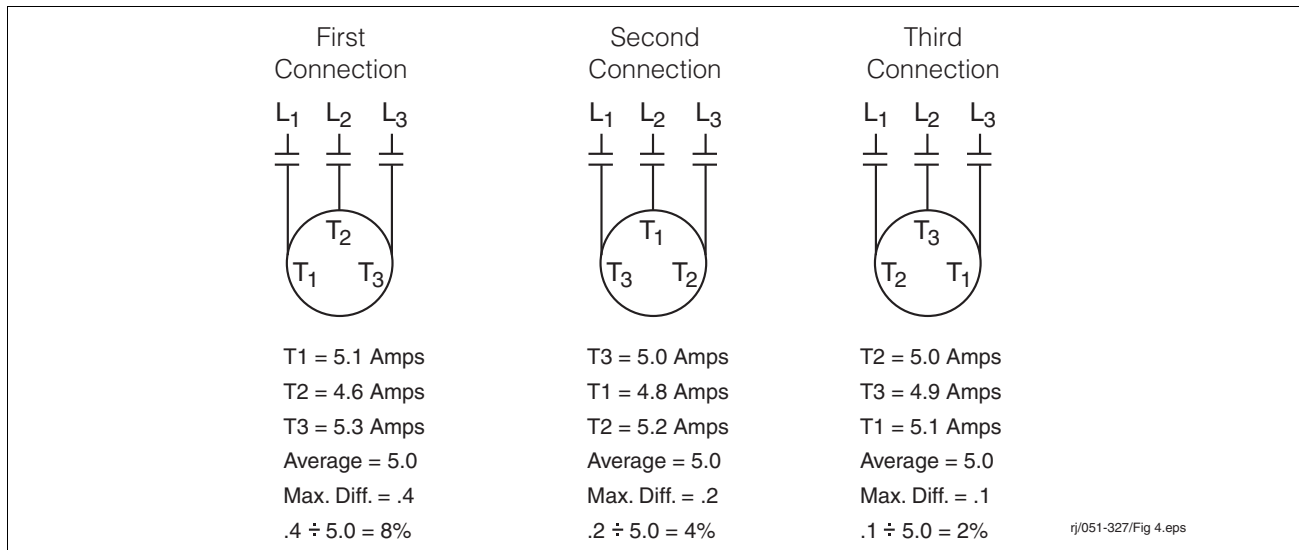

Figure 6. Example percentage of unbalance calculation

Typical System Schemes with Submersible LPG Pump-Motor Unit

General

There is always a certain risk involved in the handling of "Liquefied Petroleum Gas" (LPG or Autogas). The risk of occurrence of the most serious hazard, a "BLEVE" (Boiling Liquid Expanding Vapor Explosion) of the storage tank, is practically eliminated by installing the storage tank underground or by coverage with a mound of sand.

In spite of technical safety measures specified in this manual other hazards remain possible. In order to reduce the risk, each person who is involved in any way with operation, installation, maintenance or repair must read and apply the safety instructions fully.

All national and local applicable safety regulations must be applied.

When and where the LPG installation has displayed additional safety regulations, these should be followed.

Although great care has been taken in the preparation of this manual, Veeder-Root shall not be liable for any misunderstanding, errors and/or loss or defects arising from the use of this manual.

Design codes and local regulations must be followed.

LPG storage tanks and manifolds are classified as unfired pressure vessels, which are subject to the inspection and acceptance of the inspection agency. LPG manifolds shall be designed, fabricated and tested as a minimum in accordance with the ASME section VIII Boiler and Pressure Vessel Code division 1, or with BS 5500, both supplemented with requirements of local regulations.

Design and Test Pressures

The design pressure shall be equal to the maximum vapor pressure of commercial grade propane at an ambient temperature of 323°K (50°C) that amounts to approximately 1780 kPa (258 psi).

The hydrostatic test pressure shall be 1.4 times the design pressure = 2500 kPa (363 psi).

Material

LPG tanks shall be manufactured from carbon steel or low alloy-steel, e.g., ASTM A-285C, A-515Gr.55 or 60, DIN 17155H or similar material.

Flanges

All nozzles shall have welding neck flanges, pressure rating PN 40, in accordance with DIN 2635, BS-4504 or equivalent. Flange material; carbon steel c22 as per DIN 17200, ASTM A-105 or equivalent.

Name Plate

Each manifold has to be provided with a stainless steel name plate containing the data in Table 7.

Table 7. Required Data on Manifold Name Plate

*a-	The registration number
*b-	The name of the product
*c-	The maximum operating pressure
*d-	The maximum test pressure
*e-	The minimum and maximum allowable operating temperature in °C
*f-	The date of the latest acceptance test
*g-	Type and model of pump
*h-	Manufacturer's name, address, year of fabrication and serial number

System Components

List of appurtenances as shown on the typical schemes of LPG service station (underground and aboveground storage tank with submersible pump).

Table 8. Example System Components

Item	Description	Size (inches)	Remarks
1	Blow-off valve	1/2	
2	Angle valve	2	
3	90% Ullage valve	1/2	
4	Check valve	2	
7	Ball valve	2	
8	Ball valve	1-1/4	
9	Ball valve	3/4	
10	Ball valve	1/2	

Table 8. Example System Components

Item	Description	Size (inches)	Remarks
11	Excess flow valve	2	
12	Excess flow valve	1-1/4	
13	Excess flow valve	3/4	
14	Remote control valve	2	
15	Remote control valve	3/4	
16	Relief valve	1/4	
17	Safety valve	-	
18	Excess flow valve - if design required	-	Optional
19	Excess flow valve - equalization line	3/4	Optional
20	Insulation joint	2	
21	Insulation joint	1-1/4	
22	Insulation joint	3/4	
23	Filling hose	3/4	
24	Filling nozzle	3/4	
25	Break-away coupling	3/4	
26	Hose connection with cap	3-1/4	
27			
28	Level indicator	-	
29	Pressure gauge	1/2	
30	Pressure control valve	1/4	
31	Ball valve	2	
32	Connection rod	-	
33	Red Jacket submersible pump	125 mm (5 in.)	Minimum opening
34	Vent of pump well + equalization line		

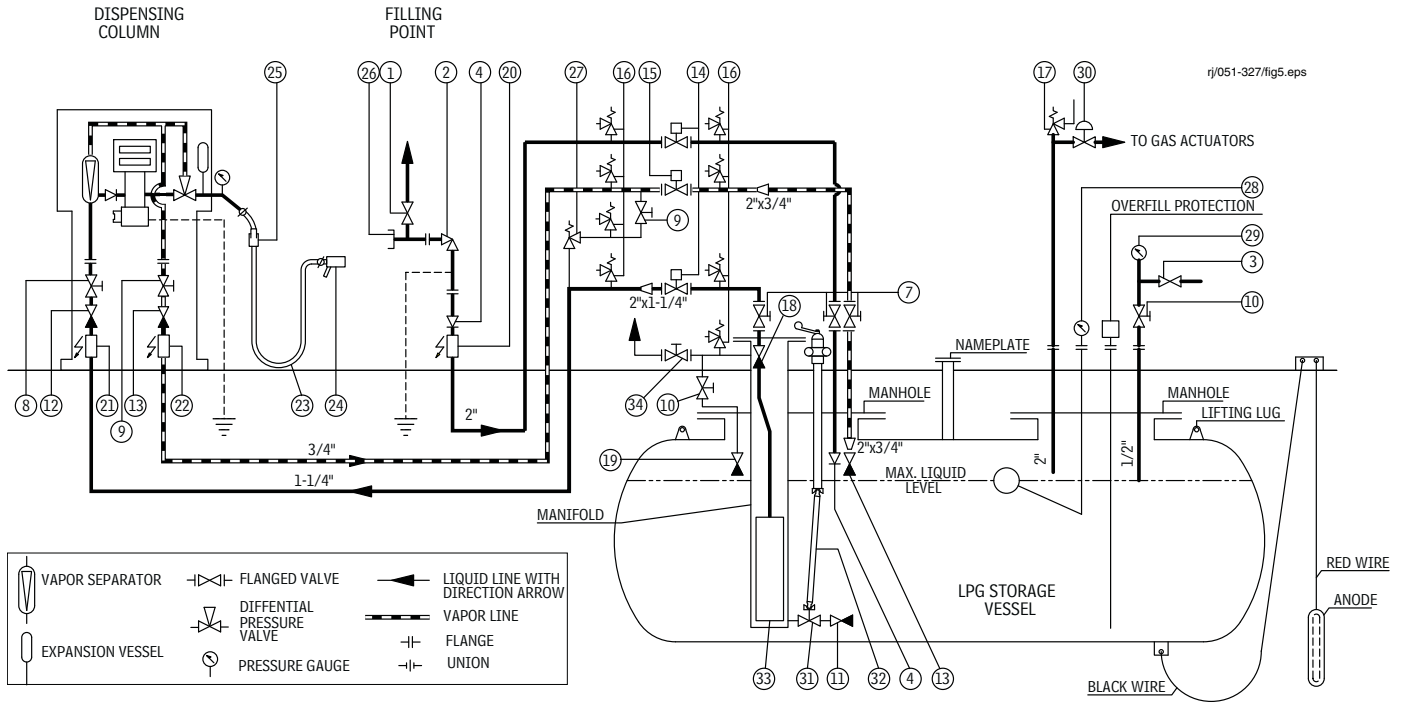

Figure 7. Typical Scheme For An Underground LPG Storage Tank With Vertical Submersible Pump-Motor Unit

Table 9. Minimum Design Requirements Vertical Manifold

<p>Premier Nomenclature: LPG300V17-21</p>	Excess flow valve (Inlet) minimum 462 liter/min. (122 gallon/min.) liquid
	Ball valve 2"
	Pump well or opening: 5 in. (125 mm) minimum
	Outlet: 1-1/2 - 2 in.
	Equalization line: length: as short as possible diameter: minimum 8 mm (0.31 in.)
	Excess flow valve (If design required in equalization line): minimum 78 liter/min. (20 gallon/min.)
<p>Premier MidFlow Nomenclature: LPG300V17-17</p>	Excess flow valve (Inlet) minimum 462 liter/min. (122 gallon/min.) liquid
	Ball valve 2"
	Pump well or opening: 5 in. (125 mm) minimum
	Outlet: 1-1/2 - 2 in.
	Equalization line: length: as short as possible diameter: minimum 8 mm (0.31 in.)
	Excess flow valve (If design required in equalization line): minimum 78 liter/min. (20 gallon/min.)
<p>Premier Hiflow Nomenclature: LPG500V17-24</p>	Excess flow valve (Inlet) minimum 462 liter/min. (122 gallon/min.) liquid
	Ball valve 3" or 2" limit restrictions
	Pump well or opening: 5 in. (125 mm) minimum
	Outlet: 1-1/2 - 2 in.
	Equalization line: length: as short as possible diameter: minimum 8 mm (0.31 in.)
	Excess flow valve (If design required in equalization line): minimum 78 liter/min. (20 gallon/min.)

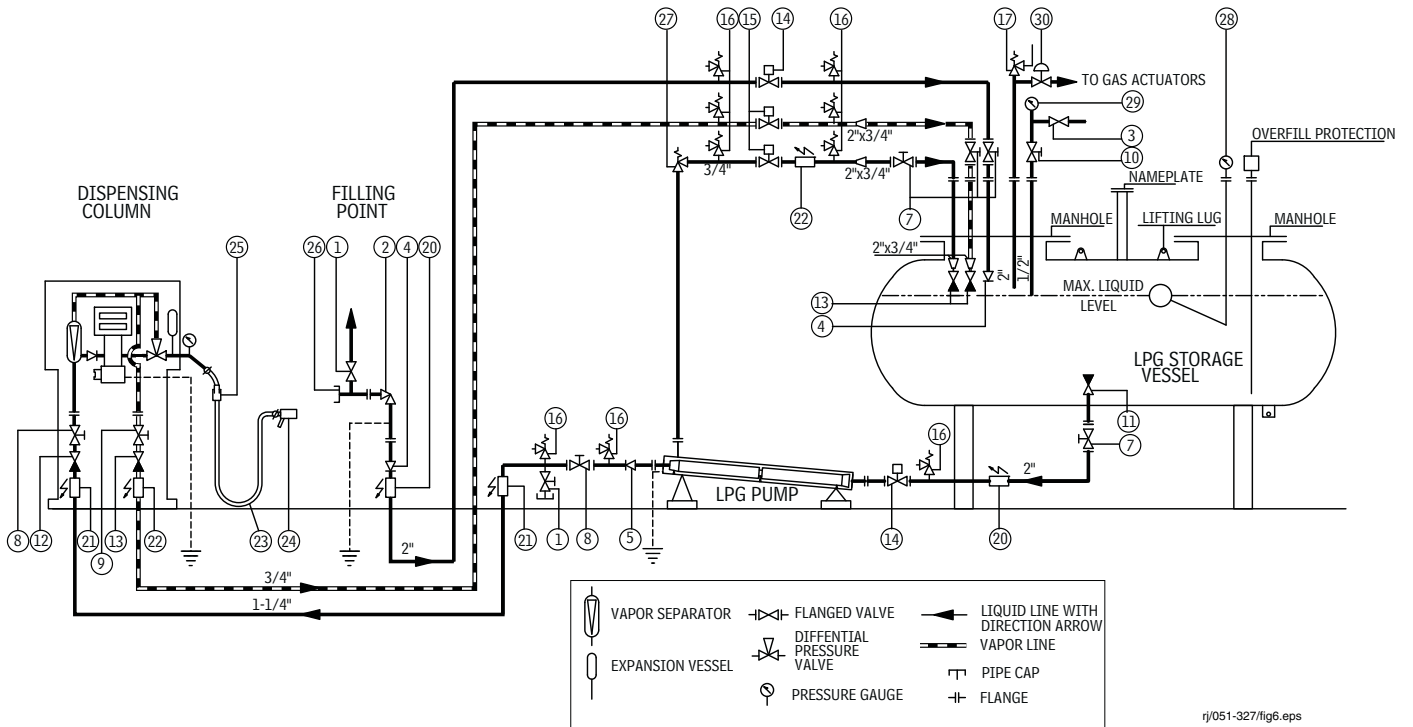

Figure 8. Typical Scheme For An Aboveground LPG Storage Tank With Horizontal Submersible Pump-Motor Unit

Table 10. Minimum Design Requirements Horizontal Manifold

<p>Premier Nomenclature: LPG300V17-21</p>	Excess flow valve (Inlet) minimum 462 liter/min. (122 gallon/min.) liquid
	Ball valve 2"
	Manifold: 6.9 in. (175 mm) minimum
	Outlet: 1-1/2 - 2 in.
	Vapor return line 3/4 in.
	Excess flow valve (Vapor return line): minimum 78 liter/min. (20 gallon/min.)
	Pump unit must be supported by three support-arms: a. the inlet, b. discharge-head, and c. at the pump flange (i.e., /DSI PA/PE 4-38 Pipe Isolator)
	Manifold : must be installed 4 - 5° upwards to avoid vapor lock in manifold
<p>Premier Midflow Nomenclature: LPG300V17-17</p>	Excess flow valve (Inlet) minimum 462 liter/min. (122 gallon/min.) liquid
	Ball valve 2"
	Manifold: 6.9 in. (175 mm) minimum
	Outlet: 1-1/2 - 2 in.
	Vapor return line 3/4 in.
	Excess flow valve (Vapor return line): minimum 78 liter/min. (20 gallon/min.)
	Pump unit must be supported by three support-arms: a. the inlet, b. discharge-head, and c. at the pump flange (i.e., /DSI PA/PE 4-38 Pipe Isolator)
	Manifold : must be installed 4 - 5° upwards to avoid vapor lock in manifold

Table 10. Minimum Design Requirements Horizontal Manifold

<p>Premier Hiflow Nomenclature: LPG500V17-24</p>	Excess flow valve (Inlet) minimum 462 liter/min. (122 gallon/min.) liquid
	Ball valve 3" or 2" limit restrictions
	Manifold: 6.9 in. (175 mm) minimum
	Outlet: 1-1/2 - 2 in.
	Vapor return line 3/4 in.
	Excess flow valve (Vapor return line): minimum 78 liter/min. (20 gallon/min.)
	Pump unit must be supported by three support-arms: a. the inlet, b. discharge-head, and c. at the pump flange (i.e., /DSI PA/PE 4-38 Pipe Isolator)
	Manifold : must be installed 4 - 5° upwards to avoid vapor lock in manifold

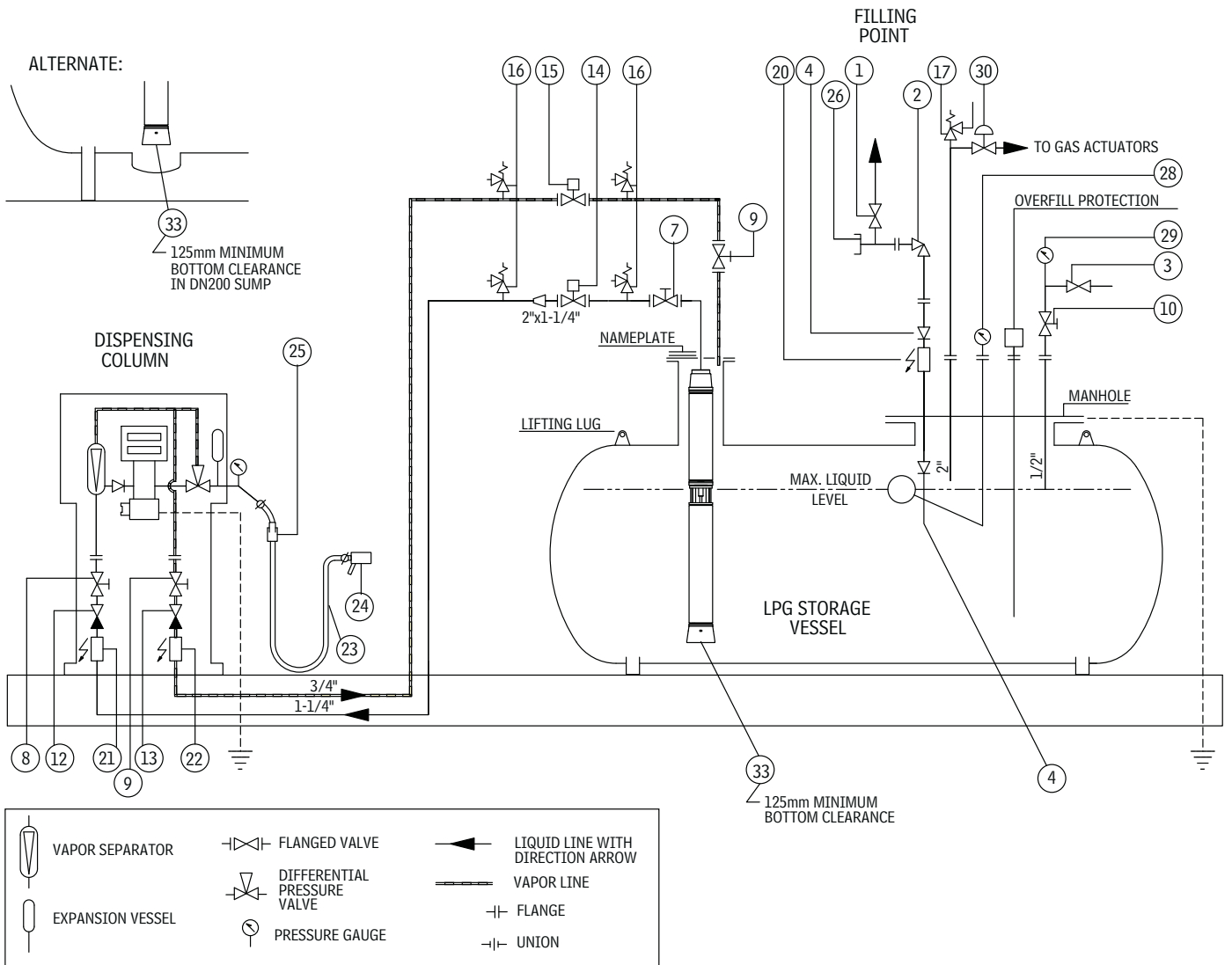

Figure 9. Typical Scheme For A Direct Installation With Vertical Submersible Pump-Motor Unit

Gas Filling

Gas Filling Requirements

- This procedure must be done by at least two duly trained technicians, one of whom is responsible for following up the safety regulations and procedures.
- Gas filling and degassing of the installation has to be done with regard to the hazardous area zone of the Autogas tank and filling point.
- All parts need to be checked to ensure they are installed correctly before the installation is placed in operation.
- During installation it is not allowed to have open fire or flammable materials within a radius of 15 meters (49 feet), or heated objects with surface temperature exceeding 300°C (572°F) or other sources of ignition.
- During fog or windless weather installation should be avoided, as gasses may not be able to evaporate quickly enough.
- Working area should be fenced and electricity shut off.
- Two (2) portable powder extinguishers of at least 6 kg (13.2 lbs) should be present for immediate use.



Gas filling procedure

1. Verify that the gas filling requirements above have been met. Make sure all fittings are tight to prevent leaks.
2. Fill the tank and manifold with nitrogen until pressure reaches 100 kPa (14.7 psi). Relieve pressure until it reduces to 15 kPa (2.1 psi).
3. Repeat the filling with nitrogen until it reaches 100 kPa (14.7 psi). Relieve the pressure until it reduces to 15 kPa (2.1 psi).
4. Fill the tank and manifold with LPG until it reaches 100 kPa (14.7 psi). Relieve the LPG pressure until it reduces to 15 kPa (2.1 psi). Note: Pressurizing the LPG tank is only allowed through the vapor nozzle of the tank truck.
5. Fill the tank and manifold with LPG until it reaches 100 kPa (14.7 psi). Relieve the LPG pressure until it reduces to 15 kPa (2.1 psi).
6. Fill the tank and manifold with LPG until it reaches 100 kPa (14.7 psi). Relieve the LPG pressure until it reduces to 15 kPa (2.1 psi).
7. Fill the tank and manifold with LPG until it reaches 100 kPa (14.7 psi). Relieve the LPG pressure until it reduces to 15 kPa (2.1 psi).
8. After Step 7. , there is maximum 1.7% air in the gas mixture, of which the oxygen concentration can be measured. The tank and manifold are now ready to be used and can be filled up to maximum 80%.
9. Check the manifold fittings by applying a mix of water and soap on all the fittings.
10. The pipe lines of the installation and dispenser should now be tested and flushed with nitrogen.

Servicing The Red Jacket LPG Pump-Motor Unit

Degassing a Manifold and Replacing a Red Jacket LPG Pump-Motor Unit

Prior to Starting



- These instructions must be followed when replacing a submersible LPG pump.
- These instructions only relate to the degassing of the manifold and the replacement of the submersible pump, and not to the dispenser which measures and register the actual sales of the product.
- The degassing of the manifold and the replacement of the Red Jacket submersible LPG pumps should only be conducted in the presence of an authorized technician.

Degassing Procedure

Degassing is the procedure by which the gas concentration in the manifold and/or related piping system is safely reduced to (and then maintained at) a level which is not higher than 10% of the lower explosion limit (LEL).

1. Disconnect the power supply of the submersible pump on the switchboard in the kiosk. (Secure the switch against switching on).
2. Close ball valve in the liquid line.
3. Connect the nitrogen cylinder to the purge connection of the manifold.
4. Close the ball valve in the equalization line.
5. Open the purge connection and fill the manifold with nitrogen (pressure max. 1000 kPa [145 psi]) until you hear the nitrogen bubbling from the inlet of the manifold.
6. Close the inlet ball valve and purge connection, secure the inlet ball valve against opening.
7. Disconnect the nitrogen cylinder.
8. Relieve the pressure of the manifold by opening the purge connection.
9. Disconnect the power cable from the junction box (mark the wires).
10. Disconnect liquid line.
11. Disconnect manifold cover.
12. Lift the pump, making sure to use suitable means for control and stability.



Replace the pump and restart the installation

1. Disconnect the pump/motor from the discharge head by unscrewing the four socket head screws.
2. Examine flange connections for corrosion roughness or small parts of old gasket. If so, smooth with fine emery paper.
3. Examine discharge head for corrosion roughness or small parts of old gasket. If so, smooth with fine emery paper.
4. Assemble the pump to the motor, and then the motor to the discharge head following the instructions contained in the section entitled 'Installing A Red Jacket Submersible LPG Pump-Motor Unit on page 18'.
5. Disconnect the pressure gauge of the liquid line.
6. Re-install the new LPG pump into the manifold, making sure to use suitable means for control and stability.
7. Make sure the flange gaskets are in place.



8. Tighten all bolts.



CAUTION: Make sure all fittings are tight to prevent possible leaks.

Filling the manifold and pump-motor unit with liquid



Avoid any risk of fire.

1. Open the purge connection.
2. Open the ball valve of the pressure gauge in the liquid line.
3. Open the ball valve of the manifold to 10% of full.
4. Close the purge connection when LPG vapor comes out.
5. Open the equalization line.
6. Open the ball valve to 40% of full.
7. Close the ball valve of the pressure gauge in the liquid line when LPG vapor comes out.
8. Open the ball valve of the manifold and secure the ball valve against closing.
9. Connect the pressure gauge.
10. Connect the power cable into the junction box and switch the power supply on.
11. Open the ball valve in the liquid line.
12. Installation is ready to start-up. If the pump makes a lot of noise during the start-up there is still compressed air in the pump. If so, stop the pump and remove the air by opening the ball valve of the pressure gauge in the liquid line and go back to Step 7.



CAUTION: Make sure all fittings are tight to prevent possible leaks before starting up the installation. Never run an LPG pump dry and avoid running a LPG pump with compressed air in the pump, this will damage the pump.

Maintenance of the Red Jacket Submersible LPG Pump-Motor Unit

There is not a requirement for initial bearing running-in period for the Red Jacket submersible LPG pump-motor units. There is also no required maintenance or servicing frequency for the pump-motor unit. All components of the pump-motor unit are designed to last for many years.

Yearly Inspections

Check pump capacity, pressure, and power. If the pump performance does not satisfy your process requirements, the pump-motor unit should be removed from the storage vessel and inspected. A Red Jacket submersible Premier, Premier Mid-Flow or Premier Hi-Flow LPG pump is not repairable. The pump and motor of all three must be replaced as a complete set, not individually unless prior approval from Veeder Root is received.

Table 11. Service Parts List

Item No.	Part Number	Qty.	Description
1	410211-001	1	Gasket
2	144-220-5	1	Discharge Head Fastener Kit - contains (4) socket head screws and (4) lock washers
3	072-725-1	1	O-ring, motor (25.4 x 1.8 mm [1.0 x 0.070 in.])
4	144-210-1	1	Pump fastener kit - contains (4) hex head screws and (4) lockwashers
5	410156-001	1	Pigtail connector, 14 AWG, 6 meter (20 ft.)
6	410109-001	1	Discharge head O-ring kit

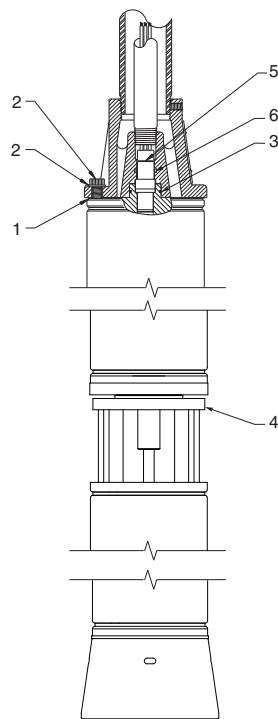



Figure 10. Service Parts

Troubleshooting Guide

The table below lists suggested troubleshooting procedures for pump related problems.

Symptom	Cause of Trouble	What to Check	How to Correct	
Vehicle Does Not Fill	AFL valve in vehicle tank not open	Contents gauge	AFL valve is faulty if tank is not full	
	Blockage in discharge line to vehicle	Compare flow rate on other lines	Clear blockage	
	Blocked filter in dispenser or nozzle	Compare flow rate on other lines	Clean filters	
	Differential pressure low	See SYMPTOM		
	Dispenser is not authorized	Power to dispenser		Re-establish power to dispenser
		Nozzle connection to vehicle		Correct connection
	High pressure in vehicle tank	Vehicle tank temperature	Cool tank or reduce number of open nozzles	
	Inadequate product in supply tank	Liquid level in supply tank	Fill supply tank	
	Pump not running	See SYMPTOM		
	Vehicle tank is full	Contents gauge	No problem exists	
Differential Pressure Low	Discharge head or pump is loose, creating pressure leak	Pump/motor assembly	Pull pump/motor assembly, check condition of O-rings and gasket. Assemble and re-tighten screws properly.	
	External bypass is set incorrectly or is faulty	Bypass	Correct bypass to required setting	
	Motor is running in wrong direction	Reverse two motor wires at the contactor	Proper connection will always provide highest pressure	
	Motor is single phased	Amperage or voltage to motor	If one leg is zero, contactor or power supply is faulty	
	Pump staging has failed	Have filters been clogged?	Clean filters and service pump	
	Restriction into pump well	Ball valve and excess flow valve	Open ball valve	
	Equalization line restricted	Ball valve in equalization line	Open ball valve or increase size	
	Too many open nozzles per pump	Single pump installation		Limit number of nozzles per pump
		Dual pump installation		Are both pumps running?
	Vapor balance line between supply tank and pump well is restricted	All valves in line	Open valves or clear obstruction	

Symptom	Cause of Trouble	What to Check	How to Correct
Low Flow Rate	Blockage in discharge line to vehicle	Compare flow rate on other lines	Clear blockage
	Blocked filter in dispenser or nozzle	Filters	Clean tank or service pump
	Differential pressure low	See SYMPTOM	
	Discharge valve not fully open	Differential pressure	Replace valve if pressure is correct
	Excess flow valve in line is shut	Return nozzle to dispenser and wait for valve to reset	Service nozzle if necessary
	High pressure in vehicle tank	Vehicle tank temperature	Cool tank or reduce number of open nozzles
Pump Not Running	Contactor coil is not engaged	Emergency stop, dispenser switch and contactor wiring	Close all switches, replace contactor or coil if faulty
	Contactor faulty	With coil engaged, is there voltage to pump?	Replace contactor
	No power	Voltage into control box	Check circuit breakers
Pump Is Noisy	Pump staging has failed	Have filters been clogged?	Clean filters and service pump
	Motor is single phased	Amperage or voltage to motor	If one leg is zero, contactor or power supply is faulty
	Motor bearings have failed	Pressure and amperage	Replace motor



For technical support, sales or
other assistance, please visit:
www.veeder.com

A blue rectangular box containing a white globe icon at the top and contact information for technical support, sales, and other assistance at the bottom.